



Phone 0086-21-6458-2196
Website www.redfoxpack.com
Email collins@redfoxpack.com
 info@redfoxpack.com
 Attn: Mr. Collins Wong

Headquarter

Redfoxpack Technology Ltd.
 Shanghai Redfox Imp.&Exp. Co., Ltd.
 58 East Xinjian Road, Suite A1908,
 Shanghai 201100 China

Facility

Anhui Redfoxpack Technology Co., Ltd.
 30 Zhaolian Road, Guangde
 Economic Development Zone,
 Anhui Province, 242200 China

工厂地址及电话

安徽丞欣包装科技有限公司
 地址: 安徽省广德市经济开发区赵联路30号
 电话: 0563-6980888
 手机: 13917750279
 联系人: 王先生

上海销售公司

上海瑞蒂进出口有限公司
 上海丞邦国际贸易有限公司
 地址: 上海市闵行区莘建东路58弄A座1908室



PRODUCTS CATALOGUE



安徽丞欣包装科技有限公司
 ANHUI REDFOXPACK TECHNOLOGY CO., LTD.

SEIKO
FINE
REDFOX PACKAGING
CREATE BEAUTY,
PACK COLORFUL LIFE!
这里是丞欣包装
创造美丽，包装多彩生活!

ABOUT US



Anhui Redfoxpack Technology Co., Ltd. is a professional manufacturer of plastic tubes, bottles and jars, for a variety applications including cosmetics, personal care, beauty, food, pharmaceutical, daily use, had sanitizer and industries.

Redfoxpack covers and owns the land of 16,000 square meters, and workshops 25,000 square meters, including Class 100,000 level GMP purification workshop, and hygiene standard purification workshop for food and pharmaceutical packaging.

Sustainable & Biodegradable Materials:

Redfoxpack has developed the sustainable and green packaging of tubes, bottles and other injection products by using PCR, PLA, PMU, OBP(Ocean Bound), Sugarcane, Paper Plastic, and Plant-based fibers such as Rose, Aloe, Olive, Fragrants, Straw, Bamboo, Tea, Wood and Coffee Ground materials which are eco-friendly and biodegradable.

Certification:

Redfoxpack is a GMP certified factory, and certificated by ISO9001, ISO14001, ISO22716, ISO45001, SA8000 and BRC certification etc. We are a SGS certified print facility and get the GMI certification for CVS pharmacy and Walgreens; Audited by UL and Costco. The products pass the testing certification of FDA food packaging, Europe Council Regulation, PPPA CR Packaging, CPSIA, US California Proposition 65, Limit of TPCH etc.

Valued Clients & Brands:

P&G Nerve, Avene, Revlon, e.l.f., Cetaphil, Avon, Mary Key, Sephora, Andrea, Hello Kitty, CVS Pharmacy, Walgreens, equate, RITE AID, Clubman, Revitol, it's 10, Palmer's, body drench, RapideX, Tower 28, Remedy, Briogeo, DUO adhesive, Toppik, DG baby, J.R. Watkins, Eva Mosaic, M&S etc.

Upgrade your products with our packaging today!

公司简介

☆安徽丞欣包装科技有限公司成立于2010年，位于安徽省广德经济开发区，占地面积25亩，现有办公及厂房面积25000平米，拥有12000平米十万级净化车间及卫生等级食品药品包装生产车间，拥有食品包装证书和国家药监局颁发的药品包装证书。公司打造智能恒温恒湿系统，更加精准控制净化生产车间的空气、尘粒、温湿度等达到高标准品质要求。

☆我司专业生产塑料软管、塑料瓶、粉饼盒、各类环保材料和降解材料包装容器，及其他注塑制品和环保制品。公司拥有六层PE管挤出机、全自动注头机、PE挤出吹瓶机、注拉吹一体机、注塑成型机、8色胶印机和6色丝网印刷机、全自动烫金机和对位贴标机、全自动组装机、智能机器人等先进的智能化生产设备和流水线。

☆公司通过**ISO9001, ISO14001, ISO22716, ISO45001, SA8000, BRC**等认证；通过SGS印刷验厂认证获得GMI证书。通过UL、Costco验厂。产品通过多项SGS, UTL检测认证。

☆公司引进先进的**智能化、自动化、数字化**智能制造智慧平台系统，实行专业的EPR, PLM, MES, WMS, AGV等数字化管理系统与AI智能管理系统工业互联，采用先进的视觉检测设备确保品质，采用无人化连线生产和车间无纸化作业，同时实行7S精益生产管理，始终为客户提供高端的品质保障和专业的技术支持，为客户提供一体化包装解决方案。**目前已与美国宝洁P&G、e.l.f.、欧莱雅、丝芙兰、雅漾、露华浓、丝塔芙、花印等国际化妆品品牌战略合作，并与珀莱雅、自然堂、优时颜、三草两木等国内一线品牌和电商品牌，以及科丝美诗、韵斐诗、科玛、如研等高端OEM加工厂商建立长期稳定的合作关系。**



十万级净化车间

Hygiene Standard GMP Purification Workshop





Sustainability

以实现可持续发展社会为目标

Redfox Packaging can safely and effectively package and enhance the value of customers' products. With the goal of achieving sustainable development, Redfox is committed to reducing pollution and impact on the environment, innovating in packaging, and developing containers made of environmentally friendly and biodegradable raw materials. www.redfoxpack.com/sustainability.html

Redfox Packaging通过有形的容器，将客户的商品进行安全美观的包装，提升产品的特性和价值。Redfox包装坚定以实现可持续发展社会为目标，必须时常考虑到容器对于环境的影响，不断探索和研发新的环保材料，积极使用循环再利用材料，同时通过使用来自甘蔗、竹木、秸秆等植物的非石油基生物物质塑料，通过使用碳酸钙无机矿物质塑料，减少石油资源的使用量，为减塑、减碳、可回收、可降解、可持续发展作出贡献。

Eco-friendly & Biodegradable Materials 【PCR, OBP, PLA, PMU, Sugarcane, Paper】

【原材料 - 回收料，海洋料，甘蔗料、降解料、碳酸钙、纸管】

By using PCR, OBP (Ocean-Bound), Sugarcane, Cornstarch, to be instead of the petroleum-based raw material, reduce the usage of the petroleum resource. The PLA is a very eco-friendly biodegradable material. Once in composting conditions, the PLA products will be composted and back to nature environment.

PMU is a mineral degradable material - calcium carbonate (CaCO₃).

By using Kraft Paper, our tubes will be 40% reduce of plastic usage, and Recycling.

Plant Based Fibers

【Rose, Aloe, Straw, Bamboo, Tea, Wood, Coffee Ground】

【植物基纤维 - 秸秆、竹纤维、茶纤维、咖啡渣、玫瑰粉】

We have developed to combine materials with plant-based fibers such as Rose Fiber, Aloe Fiber, Sakura, Olive, Fragrants, Straw, Bamboo, Tea Fiber, Wood and Coffee Ground, which are also biodegradable and can reduce the usage of petroleum raw material and effective utilization of the waste of the plant-based materials.

Unibody Tube with Conjoined Cap

【翻盖连体管 - 管盖一体注头、一体回收】

Redfox develops Unibody Tube with conjoined cap, integrated molding, no additional heading, which is reducing the usage of plastic materials, replaced of the traditional mold that a tube with heading thread then locked an additional cap. The Unibody tubes can be integrated recycling and carbon reduction.

Refillable & Replaceable, Innovation

【可替换、可再装；产品创新、技术革新】

Refillable packaging allows users to continue using a product by replacing the used-up contents in an item's original packaging. Redfox researches and develops new molds and new packaging products with new functions, by using new materials and designs, and inventing new printing and decoration technologies; Innovation and creation of new packagings offer new values to our customers and new experience feelings to the consumers.



Unibody Tube with Conjoined Cap

连体翻盖管
管盖一体注头，一体回收

- ▶ Integrated molding
- ▶ Integrated Recycling
- ▶ No additional Heading
- ▶ No additional Cap
- ▶ Plastic Reduction



Redfox develops Unibody Tube with conjoined cap, integrated molding, no additional heading, which is reducing the usage of plastic raw materials, replacement of the traditional mold that a tube with heading thread then locked an additional cap.

The Unibody Tubes can be integrated recycling and carbon reduction.
Get more: info@redfoxpack.com

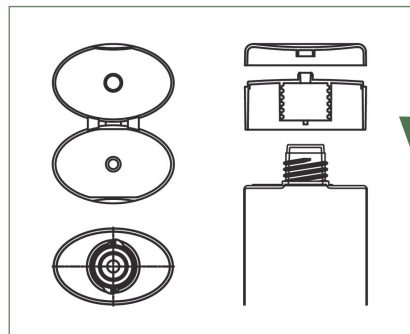

VS

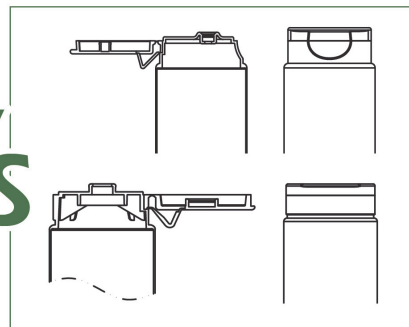

▶ Traditional Molding for a tube with an additional cap

▶ Unibody Tube with conjoined cap

PCR OBP (Ocean Bound)



回收料，海洋料

Once a material or finished products has served its intended use and has been diverted or recovered from waste destined for disposal, it is then considered "post-consumer". By including the highest amount of recycled content in each item, our containers offer some great environmental benefits, and we save resources for other uses and divert material that was headed to the landfill by repurposing it into a new product. We are excited to give a second (or third) life to the consumed containers and stuff.

Ocean-bound plastic is a term used to discuss the problematic plastic that is likely to wind up in the ocean. Most waste was not overtly destined for the ocean, but mismanagement within coastal regions may be responsible for a certain amount of spillover into these marine environments. We can use ocean bound plastic and turn it into beautiful packaging with Post-Consumer Resins.



甘蔗料

Sugarcane



Sugarcane is an example of a versatile and renewable crop that can be used as a clean source of energy and as a raw material for production of multiple products. Our Sugarcane packaging is made of the green polyethylene made from Sugarcane, which is the result of investments in innovation and commitment to the environment. By using Green Polyethylene, we can offer unique products made from renewable resources that make a significant contribution to reducing the level of greenhouse gas emissions throughout the chain.



Paper Tube

纸管、纸塑复合管



Kraft Paper Soft Tube, is made of paper tube body by connecting with plastic heading and various caps. By using Kraft Paper, our tubes will be 40% reduce of plastic, and recycling. We also can make the heading and cap with recyclable, eco-friendly or plant-based biodegradable materials, to ensure the complete tube and cap are biodegradable and sustainable. Get more: info@redfoxpack.com

PMU

碳酸钙，无机矿物质降解料

PMU is one of our new degradable materials, the main component is calcium carbonate (CaCO₃), adding food-grade polymer and MU additive, then activation treatment by physical polymer hyperdispersion modification, the ultra dispersed and activated raw materials are melted, mixed, extruded and granulated to this material.

PMU complies with ASTM D5511 Standard Testing Method, equivalent to ISO 15985:2014, which can take 779 days in nature environment (in soil and sea) for 90% of the polypropylene component to convert into CO₂, CH₄, water and biomass forms, instead of traditional industry composting.



Biodegradable Packaging

可降解包装

Biodegradable materials (pure polymer, blend product, or composite) obtained from renewable resources could be classified as green polymers, and their attributes have attracted considerable attention for their possible roles as alternatives to petrochemical-derived materials. Innovations in the development of materials from biopolymers, reductions in the use of fossil-based raw materials to decrease carbon dioxide releases, complete biological degradability coupled with decreased landfill use, and application possibilities of agricultural resources for the production of bio/green materials are just a few of the possible benefits of using biopolymers.



聚乳酸、玉米淀粉降解料

PLA Container

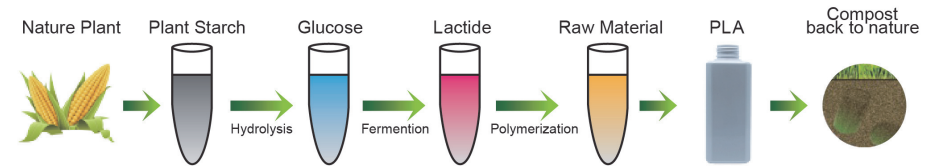

PLA (Poly Lactic Acid) is an eco-friendly material which is derived from plant-based starch. PLA is a very promising raw material, made from renewable resources, an exciting new resin derived from a renewable source, corn and other plant starches. The starched are broken down through a fermentation and distillation process and reduced to a monomer called lactide. We can make daily products from this PLA material via mold injection process. Once in composting conditions, the PLA products will be composted biodegradable and back to nature environment.

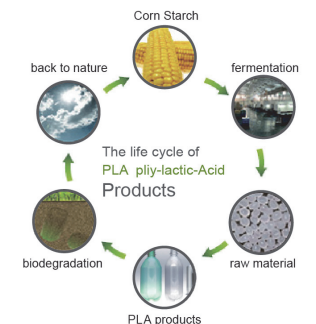

Refillable & Replaceable Containers

可替换、可再装

Creating innovative refillable packaging solution is an effective means of acting sustainably. Replaceable and Refillable packaging options are an excellent way to achieve sustainability without sacrificing efficacy and aesthetics. Redfox has developed many types of replaceable and refillable bottles and jars.



Refillable packaging allows users to continue using a product by replacing the used-up contents in an item's original packaging. This is highly convenient and reduces the waste and energy needed to manufacture new packaging, reducing the negative impact on the environment. Brands must ensure that their packaging is as environmentally friendly as possible by understanding the impact of the product on the environment, from concept to the consumer, to truly create a sustained circular economy. Get more: info@redfoxpack.com

植物基可降解料-植物纤维添加料
 秸秆、竹粉、咖啡渣、茶纤维、桂花、玫瑰花

Plant Based Biodegradable composite Materials Addable Biodegradable Fiber Materials



Feather:

- 1, Biodegradable Plant Based products can be decomposed within 90 days under industrial composting conditions;
- 2, Food Grade materials;
- 3, Application: Biodegradable Tableware, Kitchenware, Daily-use products, Disposable Lunch-box, Packing Bag, Hotel Supplies, Household Products, Stationery, 3D Print, Injection Plastic Products etc.;
- 4, We can provide: Product design, Mold drawing and tooling, Injection, Production and packing.



软管篇

Chapter I – Plastic Tube

We produce and offer flexible PE tube, Laminate ABL tube, PBL tube, Lazer tube, PCR tube, Sugarcane tube and Biodegradable tube with: layers from mono-layer, double-layer to five-layer EVOH tube; shapes from round, oval to flat shape; diameters from 12.7mm to 60mm; capacities from 2ml to 500ml, custom length of tube body (adjusted within the range of tube capacity); decorations up to eight-color offset printing, six-color silkscreen printing, hot-stamping and labeling as well as gliding technics; colors from transparent, white to colored; coating finish in gloss, matte and soft touch; caps in screw cap, stand up fez cap, screw-on flip top, snap-on positioned flip top, nozzle tip cap, ribbed screw cap, tear-off cap, acrylic cap, anti-backflow valve cap, center-dispensing twist off cap, mascara brush tip, felt tip, silicone tip, dropper tip, roll-on ball tip, cotton tip, comb, airless pump, metal and ceramic applicator etc. with custom colors and shapes.

我司生产的塑料软管有双层、五层PE软管，铝塑复合管，全塑复合管及高亮镀铝片材管，同时可生产PCR和可降解等环保材料软管，管径规格包括Φ13、16、19、22、25、30、35、40、45、50、55、60mm，管型包括配套金属头、陶瓷头、毛刷头、植绒头、硅胶头、滴管头、滚珠头、棉签头、唇膏头、按摩头、震动头、拧断头、防盗盖、撕拉盖、旋转牙盖、亚克力盖、防回流盖等各类软管和椭圆管，及各类尖嘴医药管和机油管等。产品被广泛应用于化妆品、美容美发、个人护理，日用品、洗手液、消毒液、医药、食品、宠物用品、化工等领域。

软管直径、容量及长度规格示意图表

TUBE DIMENSIONS - VOLUME TO SIZE CHART																			
圓形管 Round Tube Series															橢圓管 Oval Tube Series				
容量 VOLUME	Inches > Dia.(mm)	1/2"	5/8"	3/4"	7/8"	1"	1-3/16"	1-3/8"	1-1/2"	1-9/16"	1-3/4"	2"	2-3/16"	2-3/8"	Φ30	Φ35	Φ40	Φ50	
ml	fl oz	Φ13	Φ16	Φ19	Φ22	Φ25	Φ30	Φ35	Φ38	Φ40	Φ45	Φ50	Φ55	Φ60					
2ml	0.07	45																	
3ml	0.10	49																	
5ml	0.17	60	50																
8ml	0.27		62	50															
9ml	0.30		66	55															
10ml	0.33		70	60															
12ml	0.40		81	68															
15ml	0.50		97	80	66														
20ml	0.67		98	81	69										72				
25ml	0.83			118	96	80									81				
30ml	1.00				110	91	70								90				
35ml	1.17				124	102	78								99				
40ml	1.33					112	86								118	85			
45ml	1.50					132	95	85							127	91			
50ml	1.67					142	103	90							136	97			
55ml	1.83						111	95							145	103			
60ml	2.00						118	100	88						154	109	85		
65ml	2.17						125	106	93	87					115	90			
70ml	2.33						132	111	98	92					121	95			
75ml	2.50						139	117	103	97					127	100			
80ml	2.67						146	123	108	102					133	105			
85ml	2.83						153	128	113	107	92				139	110			
90ml	3.00						160	134	118	112	96				145	115			
95ml	3.17							140	123	117	100				151	120			
100ml	3.33							145	128	122	104				157	125			
105ml	3.50							150	133	127	108				163	130	110		
110ml	3.67							155	138	131	112				169	135	114		
115ml	3.83							160	143	135	116				175	140	118		
120ml	4.00							165	148	139	120					145	122		
125ml	4.17							170	153	143	124					150	126		
130ml	4.33								158	147	128	110				155	130		
135ml	4.50								163	151	132	113				159	134		
140ml	4.67								168	155	136	116				163	138		
145ml	4.83								173	159	140	119				167	142		
150ml	5.00								178	163	144	122				171	146		
155ml	5.17									167	148	125				175	150		
160ml	5.33									171	152	128					157		
170ml	5.67									179	160	134					164		
180ml	6.00										168	140	126				171		
190ml	6.33										176	146	133				178		
200ml	6.67										184	152	140	120					
210ml	7.00											157	147	124					
220ml	7.33											162	154	128					
230ml	7.67											167	161	132					
240ml	8.00											172	168	136					
250ml	8.33											177	175	140					
300ml	10.00											206	187	160					
375ml	12.50													190					
400ml	13.33													200					

Soft Touch Coating Tube

软性柔感表面处理 软管

Soft Touch Feeling
Dreaming the Beautiful Princess

Available for
all tube types and sizes.

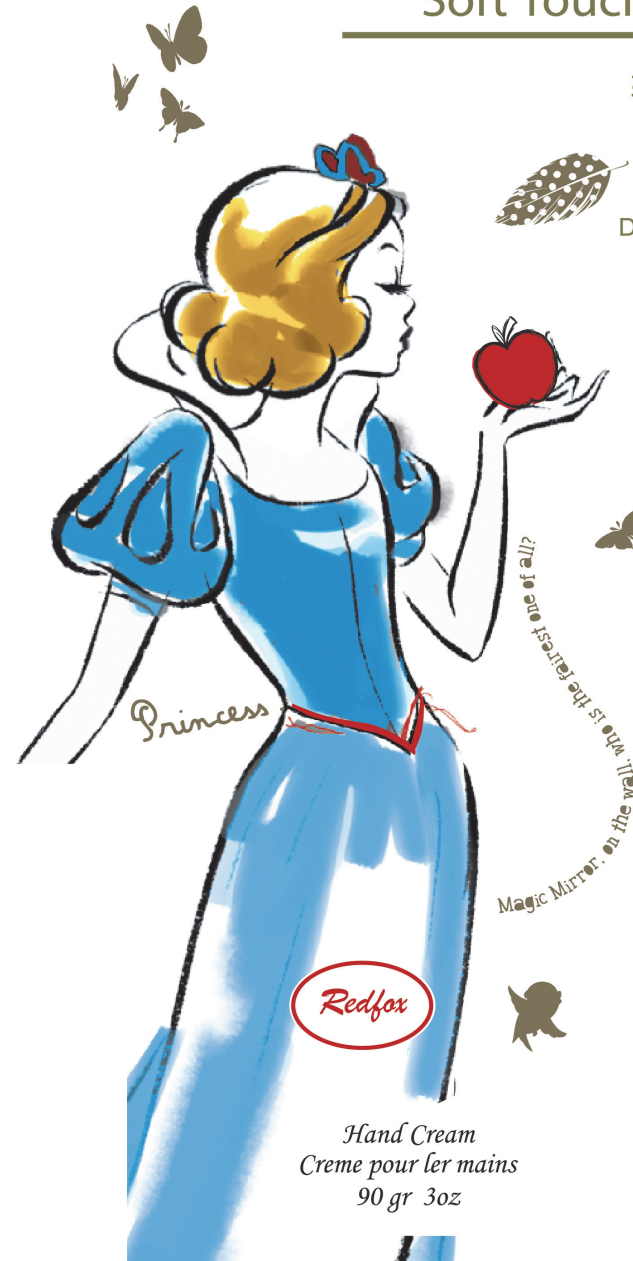

软性柔感软管，手感柔滑
适用于各种高档化妆品和护肤品，
所有软管包装规格和型号均可提供

每个女人心中住着一个公主梦
每支软管提供柔软舒服的手感
梦幻般的感觉，丝丝嫩滑

Tube with Child Resistant Cap

-PPPA CR Cap Certified

-Pilfer Proof Cap, Push Down & Turn Cap

Certificate of Conformity
Child Resistant Packaging

<p>CRC-18N</p> <p>Redfox Plastic Packaging Ltd.</p> <p>registered at 30 Zhaolian Road, Guangde Industrial Area, Xuanchen City, Anhui Province, 242200</p> <p>is certified to conform with the criteria of 16 CFR 1700.15 - Poison Prevention Packaging Standards, Food Drug & Cosmetic Act § 502(p) of Food And Drug Administration of Department of Human Health and Services</p>	 <p>PPPA CR Packaging Certified</p> <p>16 CFR 1700.15 (FD&C Act § 502(p))</p>
--	--



Specification Sheet

Dia.	Length	Capacity
25mm	60-142mm	18-50ml
30mm	65-150mm	25-85ml
35mm	80-165mm	45-120ml
40mm	87-170mm	65-150ml
50mm	110-220mm	130-320ml

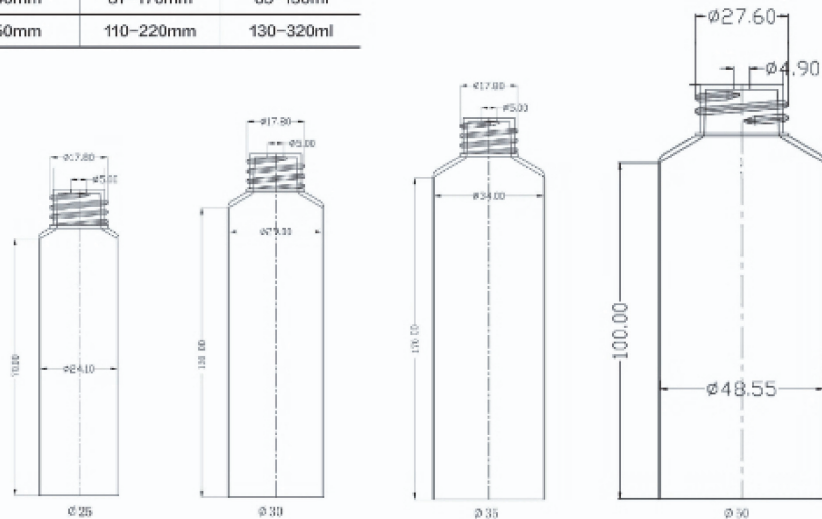

Tube with Center-Dispensing Twist Off Cap (with both Plastic and Aluminum Shell)



Specification Sheet

Dia.	Length	Capacity
30mm	70-150mm	30-80ml
40mm	87-170mm	65-160ml
50mm	110-180mm	130-250ml

金属、塑料旋转盖
新型软管

中心出料，洁净时尚；
新型设计，大牌风范。



D30 Sponge Roller, Ball Roller, Silicone Brush of new functional tube

D30海绵滚轮/不锈钢滚轮/硅胶刷等新型组合软管



Sense of clean, beauty and security with 180 degree Turn & Off rotary switch
Used for: foundation/BB cream/lift treatment/neck cream/ face mask /hair density serum.

Extreme naked makeup effect with Sponge roller applicator;
Improve absorption, anti-wrinkle with smooth cool feeling roller ball applicator;
Unique slant silicone applicator with anti-back flow function.



D13mm Tube

NO.1

Cotton Tip Tube

NO.2

Nozzle Tip Tube with Tear-off Cap

NO.3

Nozzle Tip Tube with Bullet Cap & Smooth Screw Cap

NO.4

Flat Head with Smooth Screw Cap

NO.5

Twist-off Tube



D16mm & D19mm Tube

- NO.1 Flat Head with Smooth Screw Cap
- NO.2 Nozzle Tip Tube with Tear-off Cap
- NO.3 Nozzle Tip Tube with Bullet Cap & Smooth Screw Cap
- NO.4 Twist-off Tube
- NO.5 Dropper Tip Tube
- NO.6 Tube with Felt, Brush, Silicone, Roll-on Ball
- NO.7 Tube with Mascara Brush, Lip Brush, Eyelash
- NO.8 Tube with Twist on-off head - Brush, Felt, Silicone, Metal Roller
- NO.9 Tube with Metal and Ceramic Applicator

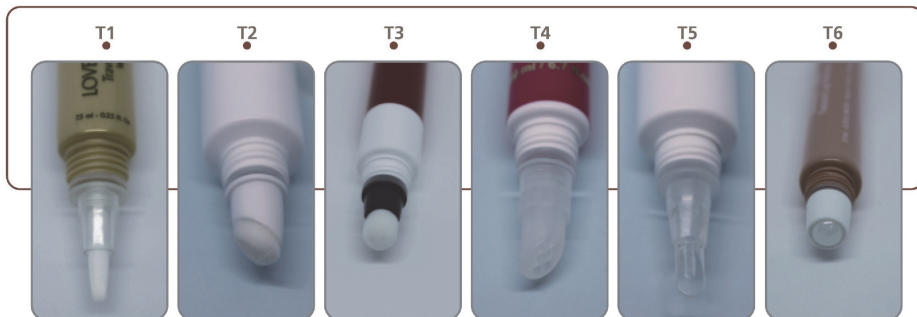
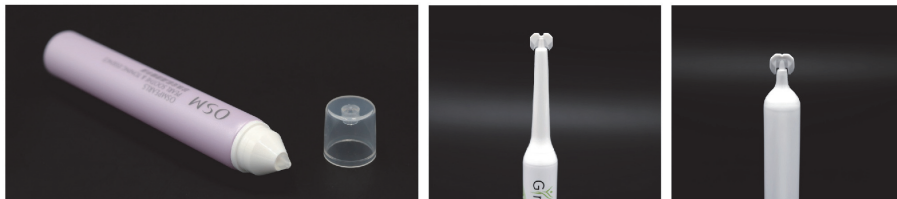

- NO.10 Slanted Lip Balm Tube
- NO.11 Airless Pump Tube
- NO.12 Tube with Trumpet-shaped Cap

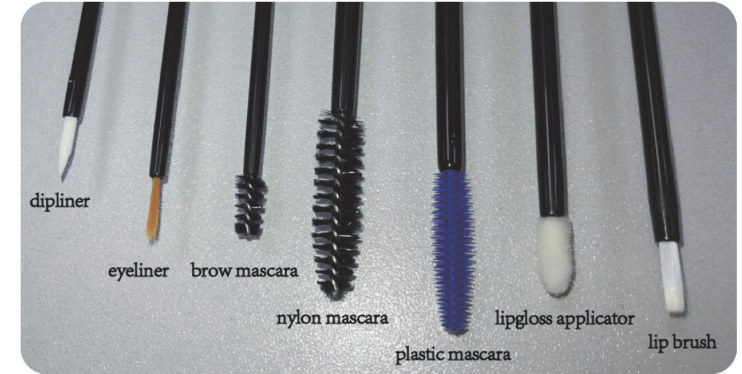

D22mm Tube



- 01 Flat Head with Smooth and Ribbed Screw Cap, Acrylic Cap
- 02 Nozzle Tip Tube with Bullet Cap & Smooth Screw Cap
- 03 Dropper Tip Tube
- 04 Dome Lip Gloss Tube
- 05 Comb Tube



D25mm Tube



- 01 Flat Head with Smooth Screw Cap & Flip Top Cap, Acrylic Cap
- 02 Nozzle Tip Tube with Bullet Cap & Smooth Screw Cap
- 03 Concave Trimming Cap
- 04 Child Resistant Cap
- 05 Airless Pump Tube
- 06 Comb Tube



D30mm Tube

- 01 Flat Head with Smooth Screw Cap & Flip Top Cap, Acrylic Cap
- 02 Functional Tube with Sponge Roller, Ball Roller, Silicone Brush
- 03 Concave Trimming Cap
- 04 Child Resistant Cap
- 05 Airless Pump Tube
- 06 Dropper Tip Tube
- 07 Cotton Sponge Tube



D35mm Tube

- 01 Flat Head with Smooth Screw Cap & Flip Top Cap, Acrylic Cap
- 02 Nozzle Tip Tube with Bullet Cap
- 03 Unibody Tube with Conjoined Cap
- 04 Child Resistant Cap
- 05 Airless Pump Tube
- 06 Tube with anti-flow back cap
- 07 Cotton Sponge Tube



D40mm Tube

- 01 Flat Head with Smooth Screw Cap & Flip Top Cap, Acrylic Cap
- 02 Tube with Center-dispensing Twist on-off Cap
- 03 Unibody Tube with Conjoined Cap
- 04 Child Resistant Cap
- 05 3-Ball Roller Tube
- 06 Caulk Tip Tube/Lube Tip Tube
- 07 Silicone Brush Massage Tube
- 08 Ice Cream Cap
- 09 Tri-orifice Massage Tube

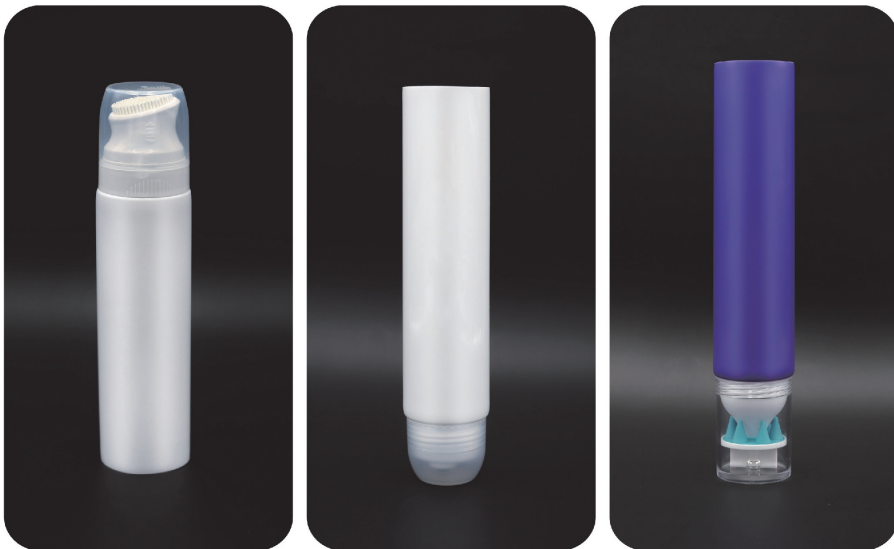

D50mm Tube

- 01 Flat Head with Smooth Screw Cap & Flip Top Cap
- 02 Unibody Tube with Conjoined Cap
- 03 Child Resistant Cap
- 04 Tri-orifice Massage Tube
- 05 Lube Tip Tube



D55mm Tube

- 01 Flat Head with Smooth Screw Cap & Flip Top Cap
- 02 Functional Tube with Brush, Roller, Silicone
- 03 Hair Adhesive Nozzle Tip Style Tube





塑料瓶，膏霜瓶

Chapter II - Bottle & Jar

We manufacture and offer Blowing Bottles, Airless Bottles and other Plastic Injection Lotion Bottles, Acrylic Jars, PETG Jars, PP Jars with single wall and double wall components;

By using the material of PET, HDPE, LDPE, MDPE, PP, AS, ABS, PETG and Acrylic (PMMA) etc.;

Shapes from Imperial Round, Boston Round, Cylinder Round, Rotatable Round, Evolution, Square, Oval, Oblique Tapered, Crystal Square and Diamond Square, Triangle, Tottle shape and other special shape and custom shape accepted;

Multiple neck sizes 18/410, 18/415, 20/410, 20/415, 24/410, 24/415, 28/410, 28/415 etc.;

Decorations up to 5 colors silkscreen printing, hot-stamping and labeling as well as shrink sleeve; Closures in screw on cap, flip top cap, snap on cap, disc cap, dropper tips, sprayer, pump, trigger and other types of closures matched with custom colors and shapes.

丞欣包装拥有全自动注塑成型机、吹瓶机及注拉吹一体机，可生产挤吹瓶、注吹瓶、真空瓶、膏霜瓶及各类注塑瓶。瓶型包括圆肩形，圆柱形，斜肩形，椭圆形，四方形，可替换装等，特殊瓶型可定制模具。瓶子种类和材质包括甘蔗料，PLA聚乳酸及可降解料，PCR可回收料，PET, HDPE, LDPE, MDPE, PP, AS, ABS, PETG, PMMA, Soft Touch 柔感原料瓶。可提供丝网印刷、贴标、缩膜、盖子点胶及塞垫片等配套服务。同时配套生产和提供种类丰富的光面和螺纹旋盖、翻盖、炮台盖、千秋盖、尖嘴盖、干燥剂盖、喷头、泵头等。产品被广泛应用于化妆品、美容美发、个人护理，日用品、洗手液、消毒液、医药、食品、宠物用品、化工等领域。

Cosmetic & Personal Care

化妆品及个人护理



Our bottles are popular in application for Cosmetic and Personal care products, including skin care, body care, face cleanser, shower gel, eye cream, eye essence, lotion and cream etc. Redfox can make our bottles with custom molds, custom colors, fantastic decoration, to help your products with charming look.

丞欣包装独特的吹瓶生产线为化妆品和个人护肤品提供定制化和多样化的瓶型和包装，可实现不同的工艺要求，使产品包装彰显优雅大气。

Beauty & Hair Care

美容美发

Our bottles are also popular in application for beauty and hair care, hair conditioner, hair gel, hair spray, make-up foundation, lip essence, eye adhesive etc. Luxury packaging of your beauty & haircare products will make your brands be confident, vibrant & beautiful!

美容美发产品是最时尚流行的产品，具有很大的市场潜力和前景。我们为美容美发产品提供高端奢华的容器包装，尽显自信和美丽！



Pharmaceutical & Health

医药健康

Pharmaceutical & Health products will be the most potential area and market in future, we can produce the bottles and meet the packaging requirement for the products.

大医疗大健康产业将是未来中国最大的消费潜在市场，大力发展健康医疗及医药产品将是重点研发和布局的领域。丞欣包装的塑料瓶容器能满足医药健康领域的包装需求。



Hand Sanitizer & Disinfectant

洗手液和消毒液

Due to the Coronavirus Pandemic, Redfox expands its production lines and produce millions and millions of bottles and caps/pumps to meet the requests for hand sanitizer and disinfectant. Quick leadtime and some stocked items available. Silk screen printing and labeling available.

丞欣包装吹瓶生产线每天可生产50万个塑料瓶，满足疫情期间及良好的日常卫生习惯对洗手液和消毒液的包装需求，可贴标可丝印，瓶型多，交期快。



Daily-use & Animal Care

日用品及宠物用品

With the booming of the daily-use and animal care products, our containers focus on the love and care for the human and animals with more convenient use and humanization design.

随着日用品和宠物用品市场的不断爆发和增长，对包装的需求也越来越独特和人性化，我们的塑料瓶容器不断体现人性化的爱和关怀，更简洁实用。

Industry & Chemical

工业及化工用途

Our bottles can use in some industrial and chemical area, for the caulk, lubricant, lube, adhesive, seam repair, shoe polish etc. Different bottle shape and caps/closures available.

塑料容器在工业和化工领域的用途也比较普遍，比如说润滑油、机油、填缝剂、胶水、鞋油及很多其他工业用品等等。



Rotatable Airless Bottle

CAPACITY 7ml/15ml/30ml/50ml



PART MATERIAL

PART	MATERIAL
OUTER CAP	ALUMINIUM
INNER CAP	PP
BOTTLE	AS/METAL
PUMP	PP/METAL

APPLICATIONS

- Skin Lotion&Cream
- Serum, Eye Cream
- Liquid Foundation

FEATURES

- Unique and Innovative Function - Retractable Actuator
- Twist to use
- Dual Wall Effect
- Internal Spray Available
- Airless Dispensing



Item	Capacity(ml)	Dia(mm)	Height
RLA-7	15	26	88
RLA-15	20	36.5	93.6
RLA-30	30	36.5	121.6
RLA-50	50	36.5	159.4

Cylindrical Airless Bottle

CAPACITY 15ml/20ml/30ml/40ml/80ml

Item	Capacity(ml)	Dia(mm)	Height
RXL/RXF-15	15	33/26.8	89/105
RXF-20	20	26.8	120
RXL/RXF-30	30	33/26.8	112/150
RXF-40	40	26.8	167
RXL-50	80	42.5*42.5	177

PART MATERIAL

PART	MATERIAL
BOTTLE	AS
PUMP	PP/METAL



Classical Airless Bottle

15ml/20ml/30ml/50ml/80ml/100ml/120ml CAPACITY



APPLICATIONS

- Skin Lotion&Cream
- Serum, Eye Cream
- Liquid Foundation

FEATURES

- Classic&Universal Cylindrical Shape
- Easy and suitable with other related packages
- Airless Dispensing
- Airless Lotion&Spray Pump Available

Cylinder Airless Bottle

PART MATERIAL

PART	MATERIAL	Item	Capacity(ml)	Dia(mm)	Height
OUTER CAP	AS	RXZ-15	15	39	101
PUMP	PP/ALUMINIUM	RXZ-30	30	39	130
BOTTLE	PMMA	RXZ-50	50	39	145
INNER BOTTLE	PETE				

PART	MATERIAL
OUTER CAP	PP
PUMP	PP
BOTTLE	PP
BASE	PP



Item	Capacity(ml)	Dia(mm)	Height
RSZ-15	15	29	89
RSZ-30	30	33	109
RSZ-40	40	33	124
RSZ-50	50	33	140
RSZ-80	80	39	140
RSZ-100	100	39	159

Cylindrical Jar & Lotion Bottle

5ml/10ml/15ml/30ml/50ml/100ml/200ml Jar
15ml/30ml/50ml/100ml/120ml Bottle

CAPACITY

FEATURES

- Cylindrical Image
- Lotion Pump



PART MATERIAL

JAR BOTTLE

MATERIAL	PART	MATERIAL
ABS	OUTER CAP	PMMA
PP	INNER CAP	-
PMMA	OUTER BODY	PMMA
PP	INNER BODY	PP
PP	DISC	-
-	PUMP	PP

Item	Capacity(ml)	Dia(mm)	Height
RAE-5	5	34.5*34.5	28.5
RAE-10	10	52*52	35.5
RAE-15	15	62*62	39
RAE-30	30	62*62	45
RAE-50	50	72*72	49
RAE-100	100	84*84	64
RAE-200	200	92*92	85.3
RBD-15	15	33*33	113
RBD-30	30	33*33	142
RBD-50	50	37*37	159
RBD-100	100	44*44	180.2
RBD-120	120	47*47	190

Sphericity Jar & Lotion Bottle

15ml/30ml/50ml/70ml Jar
15ml/30ml/50ml/80ml/100ml/120ml Bottle

CAPACITY

FEATURES

- Sphericity Image
- Lotion Pump



PART MATERIAL

JAR BOTTLE

MATERIAL	PART	MATERIAL
ABS	OUTER CAP	PMMA
PP	INNER CAP	-
PMMA	OUTER BODY	PMMA
PP	INNER BODY	PP
PP	DISC	-
-	PUMP	PP

Item	Capacity(ml)	Dia(mm)	Height
RAX-15	15	57.5	52.3
RAX-30	30	65.4	61.1
RAX-50	50	74.1	70.2
RAX-70	70	75	78
RLM-15	15	32.2	53
RLM-30	30	41	120.2
RLM-50	50	41	140.4
RLM-80	80	49	160.5
RLM-100	100	49	176.2
RLM-120	120	49	180.2

Classical Square Jar & Lotion Bottle

Item	Capacity(ml)	Dia(mm)	Height
RAD-15	15	63.5*63.5	37
RAD-30	30	63.5*63.5	46
RAD-50	50	76*76	50
RAD-120	120	92*92	70
RBG-15	15	34*31	113
RBG-30	30	34*31	158
RBG-60	60	48.7*42.4	165

PART MATERIAL

JAR BOTTLE

MATERIAL	PART	MATERIAL
ABS	OUTER CAP	PMMA
PP	INNER CAP	-
PMMA	OUTER BODY	PMMA
PP	INNER BODY	PP
PP	DISC	-
-	PUMP	PP



CAPACITY

15ml/30ml/50ml/120ml Jar
15ml/30ml/60ml Bottle

Square Jar & Lotion Bottle

5ml/10ml/15ml/30ml/50ml Jar
15ml/30ml/50ml/100ml/120ml/140ml Bottle

CAPACITY

Item	Capacity(ml)	Dia(mm)	Height
RAC-5	5	22*22	24
RAC-10	10	22*22	24
RAC-15	15	60*60	40
RAC-30	30	60*60	44
RAC-50	50	68*68	48
RBS-15	15	34.9*34.9	94.7
RBS-30	30	35*35	122
RBS-50	50	35*35	147
RBS-100	100	43*43	174
RBS-120	120	44.3*44.3	179.5
RBS-140	140	47*47	192

PART MATERIAL

JAR BOTTLE

MATERIAL	PART	MATERIAL
ABS	OUTER CAP	PMMA
PP	INNER CAP	-
PMMA	OUTER BODY	PMMA
PP	INNER BODY	PP
PP	DISC	-
-	PUMP	PP



Round Waist Jar & Lotion Bottle

15ml/30ml/50ml Jar CAPACITY
15ml/30ml/50ml/80ml/120ml Bottle



APPLICATIONS

- Skin Lotion&Cream
- Liquid Foundation

FEATURES

- Round Waist Image
- Lotion Pump

Item	Capacity(ml)	Dia(mm)	Height
RAY-15	15	51	50
RAY-30	30	61	53
RAY-50	50	70	63
RLI-15	15	37	115
RLI-30	30	37	142
RLI-50	50	45	165
RLI-80	80	53	162
RLI-120	120	53	180
RLH-15	15	43	99.5
RLH-30	30	48	129
RLH-50	50	48	154

Oblique Tapered Jar & Lotion Bottle

5ml/10ml/15ml/30ml/50ml/100ml Jar CAPACITY
40ml/60ml/80ml/120ml Bottle



APPLICATIONS

- Skin Lotion&Cream
- Liquid Foundation

FEATURES

- Oblique Tapered Image
- Lotion Pump

PART MATERIAL

JAR		BOTTLE
MATERIAL	PART	MATERIAL
ABS	OUTER CAP	PMMA
PP	INNER CAP	-
PMMA	OUTER BODY	PMMA
PP	INNER BODY	PP
PP	DISC	-
-	PUMP	PP

Item	Capacity(ml)	Dia(mm)	Height
RAP-5	5	32	29
RAP-10	10	56	35.9
RAP-15	15	67	44
RAP-30	30	67	48
RAP-50	50	76	53
RAP-100	100	87.5	67
RLL-40	40	38	117
RLL-60	60	38	140
RLL-80	80	48	125
RLL-120	120	48	165

Cone Jar & Lotion Bottle

15ml/30ml/50ml Jar CAPACITY
15ml/30ml/50ml Bottle

APPLICATIONS

- Skin Lotion&Cream
- Liquid Foundation

FEATURES

- Cone Image
- Lotion Pump



PART MATERIAL

JAR		BOTTLE
MATERIAL	PART	MATERIAL
ABS	OUTER CAP	PMMA
PP	INNER CAP	-
PMMA	OUTER BODY	PMMA
PP	INNER BODY	PP
PP	DISC	-
-	PUMP	PP

Item	Capacity(ml)	Dia(mm)	Height
RAH-5	5	32	28.5
RAH-10	10	56	35.1
RAH-15	15	67	42
RAH-30	30	67	45
RAH-50	50	76	49
RAH-100	100	88	82
RLG-15	15	37	111
RLG-30	30	40	131
RLG-50	50	40	153
RLG-80	80	49	137
RLG-120	120	49	178

Crystal Square Jar & Lotion Bottle

15ml/30ml/50ml Jar CAPACITY
15ml/30ml/50ml/100ml Bottle



APPLICATIONS

- Skin Lotion&Cream
- Serum

FEATURES

- Crystal Square Image
- Lotion Pump

PART MATERIAL

JAR		BOTTLE
MATERIAL	PART	MATERIAL
ABS	OUTER CAP	PMMA
PP	INNER CAP	-
PMMA	OUTER BODY	PMMA
PP	INNER BODY	PP
PP	DISC	-
-	PUMP	PP

Item	Capacity(ml)	Dia(mm)	Height
RJS-15	15	47.5*47.5	47.5
RJS-30	30	54.5*54.5	55
RJS-50	50	69*69	67
RBR-15	15	35*35	108
RBR-30	30	35*35	137
RBR-50	50	35*35	173
RBR-100	100	39*39	180



XD SERIES

HDPE_
PE_

Data_

容量	高(H)×直径(D)
60ml	60mm*42mm
120ml	82mm*50mm
220ml	102mm*59mm
300ml	115mm*63mm



XD SERIES 300ml XD SERIES 220ml XD SERIES 120ml XD SERIES 60ml

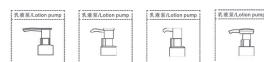

Nesse_



K SERIES

PET_

Data_

容量	高(H)×直径(D)
60ml	
120ml	
150ml	
180ml	

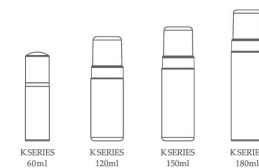

K SERIES 60ml K SERIES 120ml K SERIES 150ml K SERIES 180ml

Optional accessories_Ø43

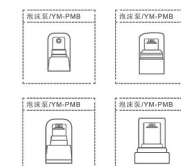

A SERIES

PET_

Data_

容量	高(H)×直径(D)
100ml	98mm*38.8mm
150ml	125mm*43mm
200ml	146.5mm*45mm
250ml	144mm*50mm
450ml	167mm*63mm



A SERIES 100ml A SERIES 150ml A SERIES 200ml A SERIES 250ml A SERIES 450ml

Optional accessories_Ø24

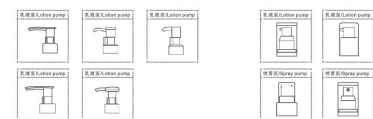

Nesse_

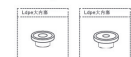

XA SERIES

PET_

Data_

容量	高(H)×直径(D)
60ml	
100ml	
120ml	
140ml	

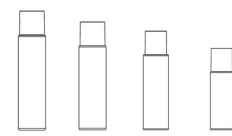

XA SERIES 140ml XA SERIES 120ml XA SERIES 100ml XA SERIES 60ml



Optional accessories_Ø27





KG SERIES
PET_

容量	高(H)×直径(D)
80ml	71mm*42.5mm
100ml	90mm*42.5mm
120ml	105mm*42.5mm
150ml	123mm*42.5mm
180ml	149mm*42.5mm

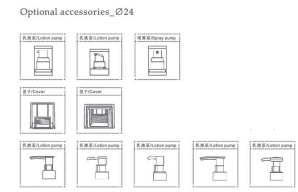
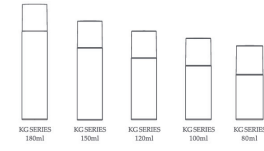

JY & KY
HDPE_

容量	高(H)×直径(D)
JY 300ml	
KY 150ml	
KY 250ml	



KH SERIES
PET_

容量	高(H)×直径(D)
80ml	71mm*42.5mm
100ml	90mm*42.5mm
120ml	105mm*42.5mm
150ml	123mm*42.5mm
180ml	149mm*42.5mm

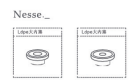
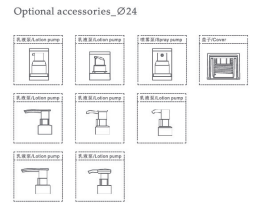
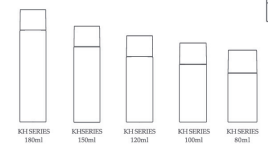

P SERIES
PET_

容量	高(H)×直径(D)
60ml	
280ml	128.5mm*59mm
300ml	120mm*67.5mm
350ml	144.5mm*64.5mm

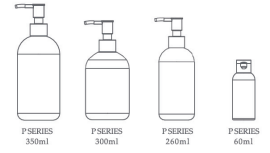



DSP SERIES
MINI CAN

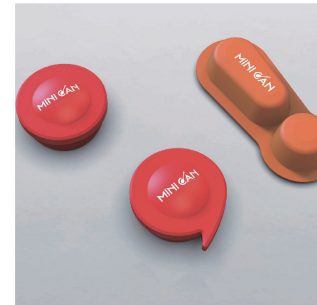

For Medicine & Pharmacy Packaging

药品包装专栏

Redfoxpack is producing all kinds of orally-taken solid and liquid medicine packing, it's authorized by the drug packaging state. We have 25,000 square meters of Class 100,000 level GMP purification workshop and hygiene standard purification workshop for food and pharmaceutical packaging. Its products, which are produced by using food/drug grade materials of PE, PET, PP, AS, ABS and PETG and widely used for packing solid and liquid medicines, health care products as well as cosmetics with nearly 300 specifications and types, are plastic containers of I category medical packing materials prescribed by State Medical Appraisal Administration.



Effervescent Tablet Bottle



Nose Dropper Bottle



Eyedrops Bottle



125ml Pilfer Proof Bottle



Flat Square Bottle



Marijuana Bottle



Measuring Cup



Long Nozzle Bottle



Pharma Cream Tube



Pharma Cream Tube

Solid-Liquid Medicine HDPE Bottle



Solid-Liquid Medicine PET Bottle

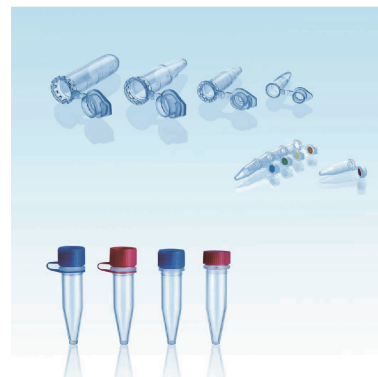

Centrifugation Tube & Freezing Tube



Centrifugation Tube

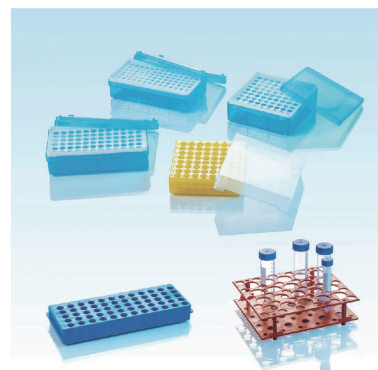

Centrifugation Tube Case

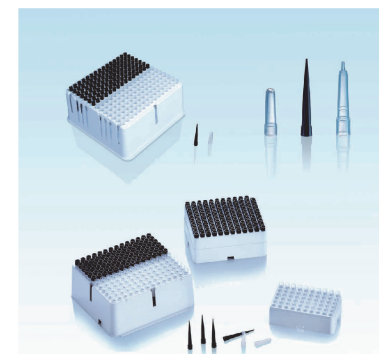

Sample Cup & Tip



Stool Specimen Collection



Stool Specimen Collection